

# PROFESSIONAL WEATHER STATION



# VP7 WIFI Manual

---

## Features:

- ▶ Perpetual Calendar Up to Year 2099
- ▶ Automatic calibration of network time service
- ▶ Day of week in 15 languages user selectable: English, German, French, Spanish, Italian, Dutch, Danish, Portuguese, Norwegian, Swedish, Polish, Finnish, Czech, Hungarian, and Slovak
- ▶ Two daily alarms
- ▶ Automatic snooze function (OFF or 5-60min)
- ▶ Temperature:
  - Maximum range of indoor temperature detection display: -20°C (-4°F) to 50°C (122°F)
  - Maximum range of outdoor temperature detection display: -40°C (-40°F) to 70°C (158°F)
- ▶ Humidity:
  - Maximum range of indoor and outdoor humidity detection display: 20% to 95%
  - Level 5 indoor and outdoor comfort display - data source temperature and humidity
- ▶ Air pressure:
  - Maximum range of atmospheric pressure measurement display:  
600 to 1100 hPa (17.72 to 32.48 inHg or 450 to 825.1 mmHg)
- ▶ Rain
  - Maximum range displayed for rainfall measurement: 0 to 9999mm (0-393.6 inches)
- ▶ Wind
  - Maximum range displayed for wind speed measurement: 0 to 180 km/h (0 to 111 mph)
  - Maximum range displayed for wind direction measurement: 0 to 359 degrees
  - Display of 12 Beaufort Wind Scale
- ▶ Light and UV index
  - Maximum range of light intensity measurement display: 0 to 128 klux (0 to 1378 kfc)
  - Maximum range of UV index measurement display: 0 to 15 level
  - Level 5 UVI sun exposure level indication
- ▶ Wireless Outdoor Sensor:
  - 433.92MHz RF transmitting frequency
  - 100 meters (300 feet) transmission range in an open area, not including walls or floors.
  - ▶ Record of temperature, humidity, wind speed, rainfall and Light intensity
  - ▶ Display of feels like temperature, wind chill temperature, heat index, dew point temperature
  - ▶ Connects directly to wifi network, connect to Time Server Connection Status
  - ▶ The weather station can upload weather information via the Wi-Fi router to "<https://www.wunderground.com>" and/or "<https://weathercloud.net>".
  - ▶ Level 4 display backlight
- ▶ Power Supply:

Weather station:

Equipment power input: DC 5V more than 1A (Power cord or power adapter)

Battery: 2 x LR6 AA 1.5V

Multi-combination Wireless Remote Sensor:

Battery: 3 x LR6 AA 1.5V

Temperature | Humidity Wireless Remote Sensor (This sensor is not configured, please purchase separately if needed)

Battery: 2 x LR6 AA 1.5V

### **F.Y.I.:**

The main unit of the weather station can operate at temperatures ranging from 0 °C to +50°C. If the function exceeds the range, it may cause abnormalities. Please use it in this environment

The wireless remote sensor can work at -30°C to +70°C. Please choose the right battery according to the limit temperature of the wireless sensor:

Alkaline zinc manganese battery can work at -20°C to +60°C

Polymer lithium ion rechargeable battery can work at -40°C to +70°C.

# VP7 WIFI Manual

## Weather Station Appearance

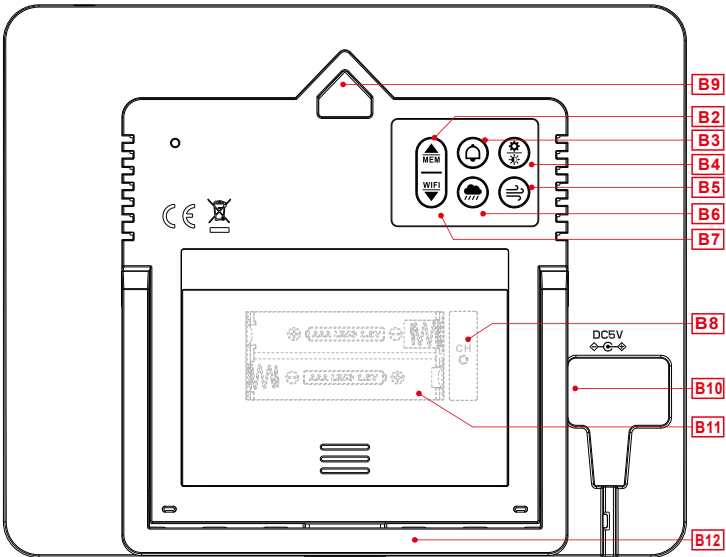
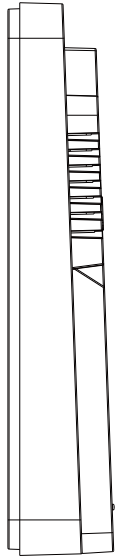
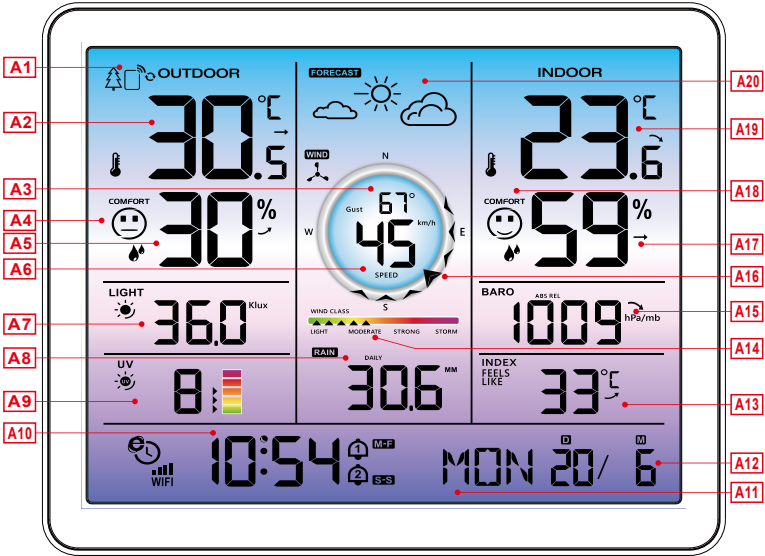
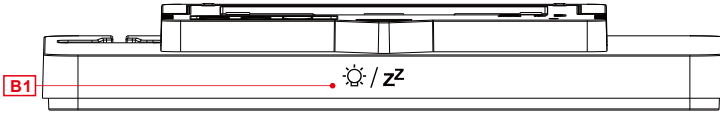

# VP7 WIFI Manual

---

## Part A-Positive LCD

- A1: Outdoor wireless channel
- A2: Outdoor temperature
- A3: Wind direction or gusts or average wind speed
- A4: Outdoor comfort icon
- A5: Outdoor humidity
- A6: Value of wind speed
- A7: Light intensity
- A8: Rainfall
- A9: UV index
- A10: Time
- A11: Day of the week
- A12: Calendar
- A13: Feels like temperature
- A14: Beaufort scale
- A15: Air pressure
- A16: Wind direction steering wheel
- A17: Indoor humidity
- A18: Indoor comfort icon
- A19: Indoor temperature
- A20: Weather forecast

 Network time Icon

 : Wireless receiving icon

 : Battery low pressure icon

 : Wireless channel loop icon

 Alarm 1 icon

**WIFI**: WIFI icon

 Alarm 2 icon

:WIFI signal strength indicator

**M-F** Monday-Friday repeat alarm icon

 Temperature | humidity | Pressure up trend arrow

**S-S** Saturday-Sunday repeat alarm icon

 Temperature | humidity | Pressure constant trend arrow

**ZZ** Alarm snooze icon

 Temperature | humidity | Pressure down trend arrow







 Multi-combination wireless sensor icon

 3 channels of temperature | humidity wireless remote sensor

# VP7 WIFI Manual

---

## Part B –Buttons and Exterior

- B1:  Snooze/Light touch location
- B7:  Rainfall related operation button
- B2:  Time and unit Setting and brightness button
- B8: "CH" Channel Switching button
- B3:  Alarm setting button
- B9: Hanging hole
- B4:  Up and memory button
- B10: Power supply socket
- B5:  Down and WIFI pairing button
- B11: Battery compartment
- B6:  Wind speed related operation button
- B12: Support frame

# VP7 WIFI Manual

## Multi-combination Wireless Remote Sensor Appearance

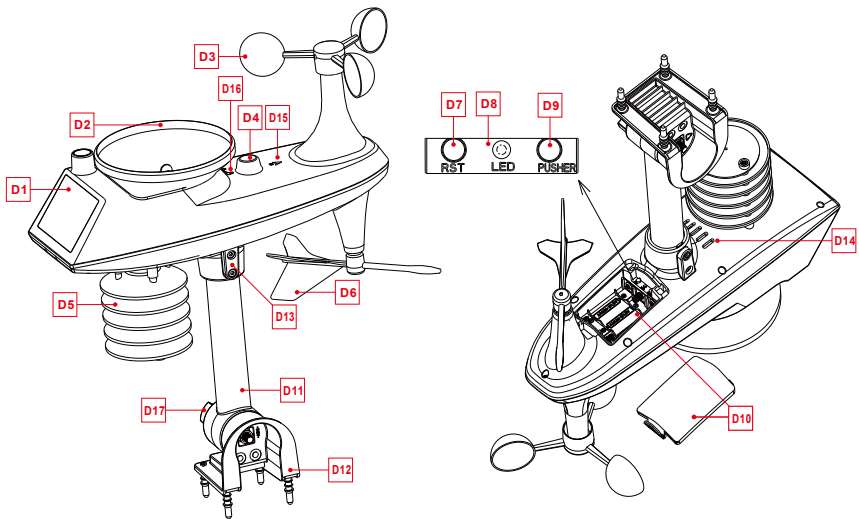

### Part D –Exterior

- D1: Solar panel
- D2: Rain funnel
- D3: Wind cups
- D4: Bubble level
- D5: Temperature | humidity induction box
- D6: Wind Directional Vane
- D7: Reset button
- D8: LED indicator
- D9: Manual transmit signal button
- D10: Battery compartment
- D11: Support rod
- D12: Fixed base
- D13: Socket head cap screws
- D14: Drain vents For rain sensor
- D15: North direction mark
- D16: Rain funnel rotation mark
- D17: Large nut for fixing the support rod and the base
- D18: Lighting and UV sensors

# VP7 WIFI Manual

## Temperature | Humidity Wireless Remote Sensor Appearance (This sensor is not configured, please purchase separately if needed)

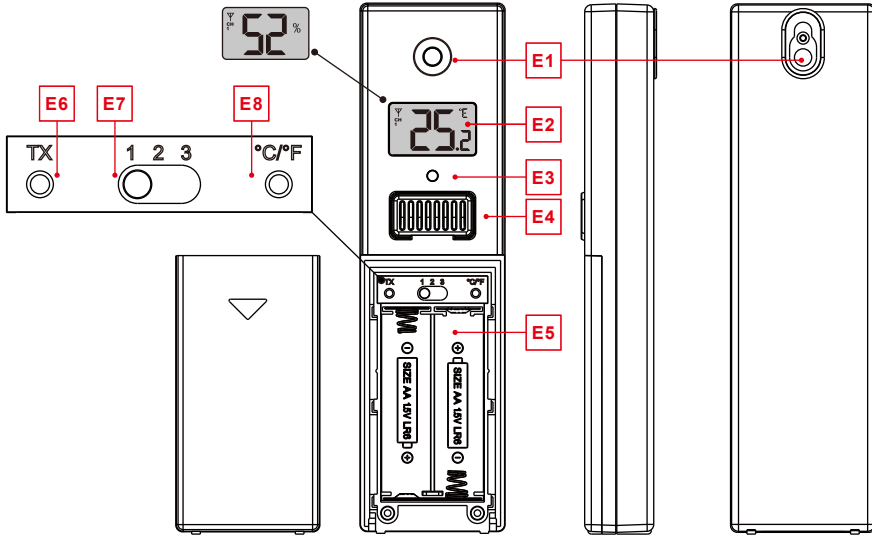

### Part E –Exterior

- E1: Hanging hole
- E2: LCD display
- E3: LED indicator
- E4: Temperature | Humidity sensing louver
- E5: Battery compartment
- E6: Manual transmit signal button “TX”
- E7: “CHANNEL 1 or 2 or 3” switch
- E8: Reset button

# VP7 WIFI Manual

---

## Setup Preparation

Items you will need to setup your station (not included):

1. Crosshead screwdriver and hex driver for assembly.
2. Fresh Batteries:
- 2 (two) AA alkaline or lithium batteries for the weather station.
- 3 (three) AA alkaline or lithium batteries for the multi-combination sensor.

### ***For best results:***

- Remove weather station and sensors from the package and place together on a table or bench, within easy reach.
- Place batteries and screwdriver within reach of setup location.
- Keep sensors and weather station 0.15-0.3 meter or 5-10 feet for at least 15 minutes after installing batteries, to allow the sensors and station to connect repeatedly.

## Quick Setup

1. Insert 3 AA batteries into the multi-combination wireless remote sensor
2. Then plug the power cord into the weather station
3. Go to <https://www.wunderground.com> and <https://weathercloud.net> to register user information and create device ID and KEY
4. The weather station can be paired with terminal devices such as mobile phones and notebooks with wireless WLAN.
5. Insert 2 AA batteries into the weather station (when the power adapter is unexpectedly powered off, the settings will not be lost)
6. Move the remote sensor to outdoor or other location after 5 minutes

## Establish a connection with the weather server

► The weather station can upload the detected weather data to "<https://www.wunderground.com>" and/or "<https://weathercloud.net>" via a Wi-Fi router. First, you need to log in to the above website to register user information and establish setting information. The specific operations are as follows:

**Note: SITES ARE SUBJECT TO CHANGE.** Each website's data privacy policy applies, please make sure you read and understand the license terms in full before accepting them!

Only accept these terms if you truly agree with them.

### ► **Account creation and device registration**

#### **Wunderground.**

Open the browser and go to the following website: "<https://www.wunderground.com>", and follow the steps shown below to quickly register the device

1. Log in or register an account



# VP7 WIFI Manual

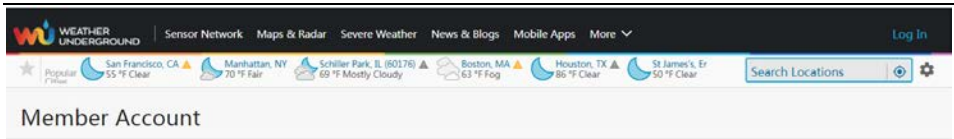

## Log In

Email

Password  [Forgot Password?](#)

If you're a Weather Underground member in the United States, your email address and password work seamlessly across wunderground.com, weather.com and The Weather Channel apps on iOS and Android.

[Log In](#)

Don't have an account? [Sign up](#)

[Terms of Use](#) | [Privacy Policy](#)

2. Click "My Profile", and then click "My Devices" to register your device after the drop-down menu pops up.



3. Click "Adding new devices" to add a new device

## Member Settings

[PROFILE](#) [SUBSCRIPTION](#) [HOME & FAVORITES](#) [MY DEVICES](#) [API KEYS](#)

### Manage Devices

[Add New Device](#)

4. Select type "other" and click "Next"

## Add a New Device

[TYPE](#) [LOCATION](#) [DETAILS](#) [DONE](#)

### Select a Device Type

25%

**Personal Weather Station**

[Next](#)

[Cancel](#)

# VP7 WIFI Manual

5. Set the location of the device on the map and click "Next"

TYPE LOCATION DETAILS DONE

### Set Device Name & Location

50%

Device Location:  
 Address  Manual  
Enter Address  
Back Next



A map of the United States with a blue location pin placed in the central region, specifically over the state of Nebraska. The map shows state boundaries and names, and includes a search bar and zoom controls in the top right corner.

6. Follow the prompts for each item, set the correct items and click "Next". (Note: The items in red are required.)

Sylvia, KS (67581)  
72°F Clear Search Locations

### Add a New PWS

TYPE LOCATION DETAILS DONE

#### Tell Us More About Your Device

75%

Name: (Required) name is required  
Give Your Device a Name

Elevation: (Required)  
1814

Device Hardware: (Required)  
other

Surface Type:

Height Above Ground:  
Ft. Above Ground

**You Make Our Forecasts More Accurate, We Respect Your Privacy**  
Contribute to the Weather Underground community by sharing some information about yourself and your sensor. We use this information to manage your account and to improve the experience from the Weather Underground community. We may also share certain data for commercial purposes, such as your sensor location.  
[Learn more about how we take your privacy seriously](#)

(Required)  
 I Accept  I Deny

Email Preferences:  
 I would like to receive PWS notifications.

Back Next

# VP7 WIFI Manual

7. After the setup is completed, the website will automatically generate the device ID and KEY. Record the ID and KEY, which will be needed when pairing the weather station.

Sylvia, KS (67581)  
72 °F Clear

Search Locations

## Add a New PWS

TYPE LOCATION DETAILS **DONE**

Registration Complete!

100%

Congratulations! Your personal weather station is now registered with Weather Underground.

Enter the information below to your weather station software.

Your PWS  
Station ID: OR34  
Station Key: 0

Copy credentials

Configure Your Software

View Devices

## Weathercloud

Open the browser and go to the following website: "https://weathercloud.net", and follow the steps shown below to quickly register the device

1. Register or log in to an account

weathercloud

About us Plans FAQ Blog Projects Get started

# Welcome to Weathercloud

The easiest way to share your weather data with the world.

### Join us today

Username  
Email  
Password

Sign up

By clicking Sign up, you agree to our [Terms of service](#) and [Privacy policy](#).

# VP7 WIFI Manual

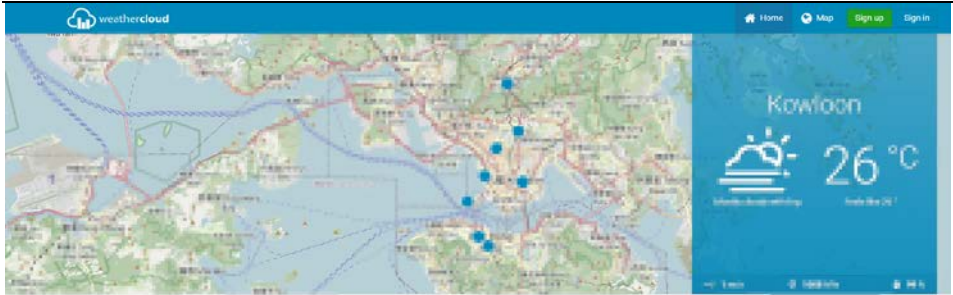

2. Click Avatar in the upper right corner, and then click " Devices" to register your device after the drop-down menu pops up.



3. Click "+ New" to create a new device



# VP7 WIFI Manual

4. Follow the prompts for each item, set the correct items and click "Create". (Note: The items with a red "\*" are required, and the MODEL and LINK TYPY items must be selected as Weather station, and the time zone and location must be set.)

### Create new device ← Back

#### Basic information

Name \*

Model \*

Link type \*

Website

Description

#### Location

Country \*

State / Province \*

City \*

Time zone \*

#### Coordinates

Latitude \*

Longitude \*

Elevation  m

Height  m

5. Click "SETTING" in the rightmost column of the corresponding device to pop up the drop-down menu, then click "Link device"

weathercloud Home Map Database Reports Plots

### Your devices + New

Status	Name	Model	Location	Gallery	Interactions
	WIFI	Weather station	<input type="text" value="KKB"/>	<input type="text" value=""/>	<input type="text" value="0 followers"/> <input type="text" value="0 views"/>
	WIFI	Other	<input type="text" value="KKB"/>	<input type="text" value=""/>	<input type="text" value="0 followers"/> <input type="text" value="0 views"/>

You follow no devices.

- 
- 
- 
- 
- 
- 
- 
- 
- 
- 
- 
- 
-

# VP7 WIFI Manual

6. After clicking, the website will automatically pop up a pop-up window showing the ID and KEY of the registered device. Record the ID and KEY, which will be needed when pairing the weather station.

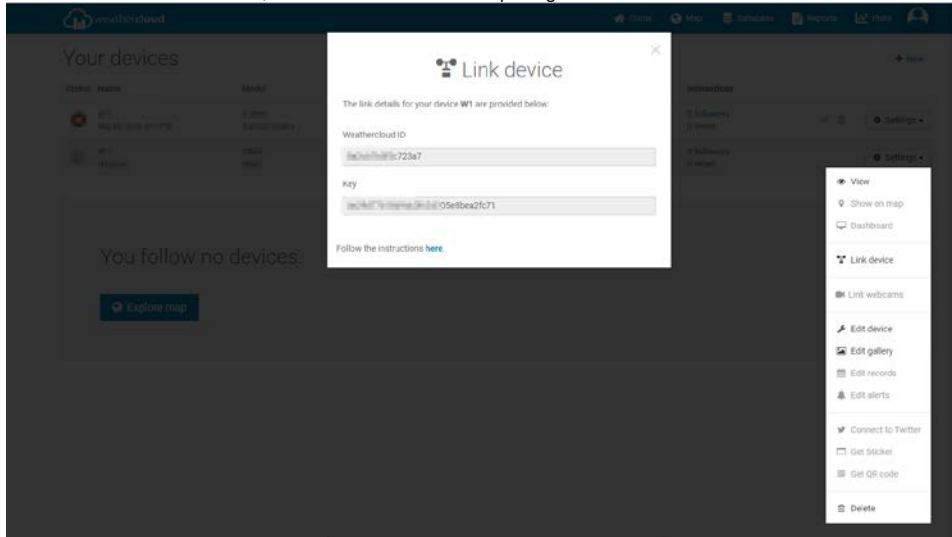

## WIFI pairing

► The weather station will automatically enter the AP pairing mode after it is turned on. The time bar will display "AP", indicating that the weather station has entered the pairing mode. If it does not enter automatically, press and hold the "WIFI" key for more than 3 seconds to enter the pairing mode.

► Turn on your mobile phone or laptop with a wireless WIFI terminal device, find the "Weather" hotspot name in the WIFI connection item, and click Connect



# VP7 WIFI Manual

*Note: The paired WIFI hotspot must be 2.4GHz, this product only supports 2.4GHz wireless network. Because the weather station's hotspot is paired with the weather station's hotspot, it will prompt that there is no network after connecting. This is normal. Make sure you don't disconnect.*

► Open the browser and enter the URL "192.168.10.1", and a pairing page will pop up automatically, as shown in the figure

Weather Settings

Language English

**Wi-Fi network setup**

Network

Select the menu and choose your 2.4 GHz WIFI router, or type in your router's name (SSID) above.

Password

Status:Connecting to router.

**Weather server setup**

Upload wunderground.com

Wunderground ID

Key

Upload weathercloud.net

Weathercloud ID

Key

**Time Zone Setup**

Time Zone

Automatically adjust clock for Daylight Saving Time

**Internet Time Server Setup**

Server

Save

► In the "Wi-Fi network setup" box, enter the name and password of the router that the Weather Station will connect to.

## Wi-Fi network setup

Network

Select the menu and choose your 2.4 GHz WIFI router, or type in your router's name (SSID) above.

Password

Status:Connecting to router.

► In the "Weather server setup" box, enter the device ID and KEY registered on the weather station website "wunderground.com" and/or "weathercloud.net".

# VP7 WIFI Manual

## Weather server setup

Upload wunderground.com

Wunderground ID

Key

Upload weathercloud.net

Weathercloud ID

Key

- ▶ In the "Time Zone Setup" column, select the time zone where the weather station is located and the time server you need to use.

## Time Zone Setup

Time Zone

Automatically adjust clock for Daylight Saving Time

## Internet Time Server Setup

Server

- ▶ After the setup is complete, click "SAVE" and wait for the prompt that the setup is successful. After the prompt, the pairing is completed and the weather station will automatically connect to WIFI and upload the device data to the website "wunderground.com" and/or "weathercloud.net"
- ▶ After waiting for a few minutes, you can see the data uploaded by the weather station on the website

## Wireless sensor connection

- ▶ The weather station can connect up to 1 Multi-combination wireless sensor and 3 different channels of temperature | humidity wireless sensor (If you need this remote single temperature and humidity sensor, please purchase separately).
- ▶ The weather station automatically searches for all wireless sensors within 3 minutes of power-on and registers the sensor IDs. Each sensor generates a random ID after power-on to distinguish the sensors.
- ▶ In the main display interface, press the "CH" button to convert the values of wireless sensors on different channels in the OUT temperature and humidity column.

**Note:** In the channel icon (where A1 is displayed), the number of channels is displayed:   (representing multiple combination wireless sensors) | CH1 | CH2 | CH3 (representing three channels of temperature and humidity wireless sensors) | Loop mode

**Note:** In the loop mode, the display of the number of channels and temperature and humidity in the OUT column switches to one channel every 5 seconds, in the order   | CH1 | CH2 | CH3. If the channel has no signal, it will automatically skip during the loop.



# VP7 WIFI Manual

**Note:** In the loop mode, only the values of temperature and humidity are being converted, and the values of wind speed, wind direction, rainfall, etc. are not converted, and the values are still derived from the Multi-combination wireless sensor.

**Note:** When the weather station loses sensor signals or the sensor is not connected to the channel, the value of the channel is displayed as "--"





▶ If you need to add a new sensor or replace a sensor, press the "CH" button to switch to the corresponding communication, and then press and hold the "CH" button for more than 3 seconds. The weather station will search for a signal for 3 minutes again, and the new channel sensor will be added to the weather station within 3 minutes.

**Note:** When adding a new sensor or replacing a sensor (old sensor replacement battery), you need to turn on the sensor power first, then follow the steps above to control the weather station.



**Note:** When the channel icon (the position of the display A15) displays the low voltage icon  , the battery of the corresponding channel wireless sensor is replaced according to the channel number of the channel icon. Then follow the steps above to re-add the wireless sensor to the weather station.

## Time and unit settings

▶ Press and hold the  button for 3 seconds to enter the time setting mode.

▶ Press the  "MEM" or  button to adjust the value. Press and hold the  "MEM" or  button to adjust quickly.

▶ Press the  button to confirm and move to the next item.

**Note:** Wait for 20 seconds without pressing any buttons, or double-click on the  /  touch key to exit the setting mode.

## Settings order:

1. Temperature unit: °C | °F
2. Pressure unit: hPa| inHg | mmHg
3. Air pressure setting: absolute or relative
4. Wind speed unit: km/h |mph | m/s | knots
5. Wind degree (angle) or direction (letter) selection
6. Rainfall unit: MM| inch
7. Light unit: Klux | Kfc | W/m<sup>2</sup>
8. Hour format: 24Hr | 12Hr
9. Hour
10. minutes
11. Calendar display format: Month/Date | Date/Month
12. Year
13. Month
14. Date
15. Week display language: a total of 15 countries
16. Initial weather forecast

**Note:**In the time setting, the minutes change automatically starting from zero seconds

**Note:** There are 15 languages of Weekday: English, German, French, Spanish, Italian, Dutch, Danish, Portuguese, Norwegian, Swedish, Polish, Finnish, Czech, Hungarian, and Slovakia

## Week language display

Language	Sunday	Monday	Tuesday	Wednesday	Thursday	Friday	Saturday
ENGLISH	MONDAY	TUESDAY	WEDNESDAY	THURSDAY	FRIDAY	SATURDAY	SUNDAY



## VP7 WIFI Manual



ENG	MON	TUE	WED	THU	FRI	SAT	SUN
GERMAN	MONTAG	DIENSTAG	MITTWOCH	DONNERSTAG	FREITAG	SAMSTAG	SONNTAG
GER	MON	DIE	MIT	DON	FRE	SAM	SON
FRENCH	LUNDI	MARDI	MERCREDI	JEUDI	VENDREDI	SAMEDI	DIMANCHE
FRE	LUN	MAR	MER	JEU	VEN	SAM	DIM
ITALIAN	LUNEDI	MARTEDI	MERCOLEDI	GIOVEDI	VENERDI	SABATO	DOMENICA
ITA	LUN	MAR	MER	GIO	VEN	SAB	DOM
SPANISH	LUNES	MARTES	MIERCOLES	JUEVES	VIERNES	SABADO	DOMINGO
SPA	LUN	MAR	MIE	JUE	VIE	SAB	DOM
PORTUGUESE	SEGUNDA-FEIRA	TERÇA	QUARTA-FEIRA	QUINTA-FEIRA	SEXTA-FEIRA	SABADO	DOMINGO
POR	SEG	TER	QUA	QUI	SEX	SAB	DOM
DUTCH	MAANDAG	DINSDAG	WOENSDAG	DONDERDAG	VRIJDAG	ZATERDAG	ZONDAG
DUT	MAA	DIN	WOE	DON	VRI	ZAT	ZON
DANISH	MANDAG	TIRSDAG	ONSDAG	TORS DAG	FREDAG	LØRDAG	SØNDAG
DAN	MAN	TIR	ONS	TOR	FRE	LOR	SON
NORWEGIAN	MANDAG	TIRSDAG	ONSDAG	TORS DAG	FREDAG	LØRDAG	SØNDAG
NOR	MAN	TIR	ONS	TOR	FRE	LOR	SON
SWEDISH	MÅNDAG	TISDAG	ONSDAG	TORS DAG	FREDAG	LÖRDAG	SÖNDAG
SWE	MAN	TIS	ONS	TOR	FRE	LOR	SON
POLISH	PONIEDZIAŁEK	WTOREK	ŚRODA	CZWARTEK	PIĄTEK	SOBOTA	NIEDZIELA
POL	PON	WTO	SRO	CZW	PIA	SOB	NIE
FINNISH	MAANANTAI	TIISTAI	KESKIVIikko	TORSTAI	PERJANTAI	LAUANTAI	SUNNUNTAI
FIN	MAN	TII	KIS	TOR	PER	LAU	SUN
CZECH	PONDĚLÍ	ÚTERÝ	STŘEDA	ČTVRTEK	PÁTEK	SOBOTA	NEDĚLE
CZE	PON	UTE	STR	CTV	PAT	SOB	NED
HUNGARIAN	HÉTFŐ	KEDD	SZERDA	CSÜTÖRTÖK	PÉNTEK	SZOMBAT	VASÁRNAP
HUN	HET	KED	SZE	CSU	PEN	SZO	VAS

# VP7 WIFI Manual

Slovakia	Pondelok	utorok	Streda	Štvrtok	piatok	sobota	nedela
SVK	PON	UTO	STR	STV	PIA	SOB	NED

## Alarm function control







- ▶ Press the  button to view the alarm 1, press again to view alarm 2, press the third time to exit
- ▶ In the mode of viewing alarm 1 or alarm 2, press the  button to turn the alarm function on or off

**Note:** When the function of Alarm 1 or Alarm 2 is turned on, the symbol “” or “” is displayed. At the same time, the relevant alarm repeat icon “**M-F**” | “**S-S**” is displayed

**Note:** The app sets the repetition icons as follows: on weekdays, only the “**M-F**” icon is displayed, on weekends, only the “**S-S**” icon is displayed, and weekly, both the “**M-F**” and “**S-S**” icons are displayed simultaneously

**Note:** Wait for 20 seconds without pressing any buttons, or double-click on the “ / **ZZ**” touch key to exit the viewing modes

## Alarm and snooze settings

- ▶ Press and hold the  button for 3 seconds to enter the alarm and snooze setting mode.
- ▶ Press the  or “” button to adjust the value. Press and hold the “” or “” button to adjust quickly.
- ▶ Press the  button to confirm and move to the next item.

**Note:** Wait for 20 seconds without pressing any buttons, or double-click on the “ / **ZZ**” touch key to exit the setting modes.

## Settings order:

1. Alarm 1 hour
2. Alarm 1 minutes
3. Alarm 1 repeat: M-F | S-S | M-S
4. Alarm 1 snooze time: 5 to 60minutes | OFF
5. Alarm 2 hour
6. Alarm 2 minutes
7. Alarm 2 repeat: M-F | S-S | M-S
8. Alarm 2 snooze time: 5 to 60minutes | OFF



**Note:** The alarm is repeatedly set to M-F, the alarm function will be activated from Monday to Friday, the Saturday and Sunday will be invalid. The alarm is repeatedly set to S-S, and the alarm function will be activated on Saturday and Sunday, and will expire from Monday to Friday. When the alarm is repeatedly set to display both M-F and S-S, the alarm function will be activated throughout the week.

**Note:** The snooze time setting range: 5 ~ 60MIN, OFF, when set to OFF, means no snooze function. Snooze time unit is minutes.

**Note:** The alarm will sound for 2 minutes if you do not deactivate it by pressing any button. In this case the alarm will be repeated automatically after 24 hours.

**Note:** Rising alarm sound (crescendo, duration: 2 minutes) changes the volume 4 times whilst the alarm signal is heard.

## Switching off the alarm signal

- ▶ When the alarm triggers, press any buttons except the “ / **ZZ**” touch button or touch and hold the “ / **ZZ**” button for more than 3 seconds to stop the alarm signal.

# VP7 WIFI Manual

## Snooze function:

- ▶ When the alarm time is reached, touch the “☀️ / ZZ” button to stop the alarm signal and enter the snooze mode. At the end of the snooze timer, it will ring again (can repeat snooze)
- ▶ In snooze timing mode, press any buttons except the “☀️ / ZZ” touch button or touch hold down the “☀️ / ZZ” touch button for more than 3 seconds to exit the snooze mode

## Temperature | Humidity | Light Intensity | UV Index | Air Pressure Reading | Record | Trend

- ▶ Press the “WIFI” button to switch the display of feel like temperature, dew point temperature, heat index and Wind chill.

**Note:** feels like temperature, dew point temperature, heat index and wind chill index is related to the value detected by the multi-combined wireless remote sensor.

**Note:** After viewing, it will automatically return to the display of feels like temperature 20 seconds later

- ▶ Press the “MEM” button to view the records of the maximum and minimum values of temperature, humidity, and light intensity.

- ▶ In the mode of viewing maximum and minimum values, press and hold the “WIFI” button for 3 seconds to clear all history of indoor temperature | Humidity and outdoor remote temperature | Humidity | light intensity and feels like temperature | dew point temperature | heat index | wind chill index

**Note:** When cleared, the above values will first be displayed as “--”, and then the current values will be re stored.

- ▶ Indoor temperature | Humidity and outdoor remote temperature | Humidity | light intensity and feels like temperature and air pressure will have trend change tips

 : Detected value is rising.

 : Detected value is dropping.

 : Detected value remains unchanged.

- ▶ There are five status indications for the UV Index: LOW (0 to 2), MODERATE (3 to 5), HIGH (6 to 7), VERY HIGH (8 to 10), EXTREME (11+).

## Wind readings | History

- ▶ In the main display interface, press and hold the “WIND” button for 3 seconds to convert the display to wind direction, gusts, or average wind speed

**Note:** WIND SPEED: average speed over the past 30 seconds

GUST WIND SPEED: Maximum average wind speed every 3 seconds for 30 seconds

AGE WIND SPEED: 10-minute average wind speed

WIND DIRECTION: Displayed in letters or degrees

**Note:** Each press and hold of the “WIND” button can only switch one item. After a successful switch, you will hear a 'B' sound. To switch to the next item, you need to press and hold the “WIND” button again

- ▶ View history: Press the “WIND” button to view the maximum wind and gust history values: 1 Hour (default) | 24 Hour | 7 Days | Month | Year

**Note:** One Hour: Data from the past 60-minute period (default top speed record, already shown)

24 Hour: Data from the past 24-hour period, starting from the last record

7 Days: Data from the past 7-day period, starting from the last record

Month: Data defined by the calendar month, for example, January 1st to January 31st

Year: Data defined by the calendar year, for example, January 1st to December 31st

- ▶ In the mode of viewing wind speed history, press and hold the “Gears” button for 3 seconds to clear all history of wind speed.

**Note:** Wind speed reading will reset to current wind speed.

# VP7 WIFI Manual

**Note:** Wait for 20 seconds without pressing any buttons, or double-click on the "☀️ / ZZ" touch key to exit the viewing modes.

## Rain readings | History

▶ In the main display interface, press and hold the "☁️" button for 3 seconds to convert the display to cumulative value of rainfall or rate of rainfall

**Note:** Rainfall: Accumulated total from current to past periods (now, 1 hour, 24 hours, day, 7 days, month, year, total)  
Rainfall rate: average hourly rainfall of daily or current rainfall events

▶ Press the "☁️" button to view the rain history, in order:

EVENT | HOURLY | DAILY | WEEKLY | MONTHLY | YEARLY | TOTAL

**Note:** EVENT: The cumulative value of the current rainfall event. If there is no rain for more than 30 minutes, it means the end of the current rainfall event

HOURLY: Total rainfall for the current hour

DAILY: Total rainfall for today.

WEEKLY: Total rainfall for the current week

MONTHLY: Total rainfall for the current month

YEARLY: Total rainfall in the current year

TOTAL: The cumulative value of the total run time (no time stamp) since the weather station was started

▶ In the mode of viewing rain history, press and hold the "⚙️" button for 3 seconds to clear all history of rain.

**Note:** The rain reading will reset to 0 mm (in).





**Note:** Wait for 20 seconds without pressing any buttons, or double-click on the "☀️ / ZZ" touch key to exit the viewing modes, The weather station will resume normal time display and display the last rainfall record you viewed. If the rain rate was displayed before entering observation mode, it will continue to display the rain rate upon returning to the normal time display from observation mode.

▶ When viewing the rainfall rate mode, press the "☁️" button to switch between displaying the daily rainfall rate or the current event rainfall rate

## Weather forecast:

▶ The weather station calculates a weather forecast for about the next 12 hours based on the barometric pressure trend. Of course this forecast can't compare to that of professional weather services supported by satellites and high performance computers, It provides only an approximate indication of the current weather development in a small local area. Please take the weather forecast from your local weather forecasting service into account as well as the forecast from your weather station. If there are discrepancies between the information from your device and from the local weather forecasting service, please take the advice of the latter as authoritative.

▶ The weather station displays the following weather icon:

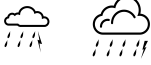
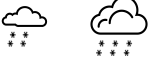
sunny	Mostly cloudy	Cloudy	Rainy	Thunder Rainy	Snowy
FORECAST 	FORECAST 	FORECAST 	FORECAST 	FORECAST 	FORECAST 

**Note:** The Snowy icon will only appear if the outdoor temperature (refers to the temperature detected by multiple combined sensors) is below -4°C (+25°F) and the forecast would be rainy or Thunder Rainy.

▶ After 7-10 days of air pressure calibration, the weather forecast tends to stabilize with an accuracy rate of 70%-75%.

## Background lighting

- ▶ If the product is powered by batteries, Press the “☀️ / ZZ” button to activate the backlight for 15 seconds.
- ▶ When the product is powered by the power supply adapter, the battery will automatically disconnect. The backlight will remain on continuously. Press the “☀️” button to adjust the backlight brightness, you can adjust the 5 state: 4 different brightness backlight and close the backlight. When the backlight brightness is not at the maximum level, press the “☀️ / ZZ” button to set the backlight to maximum brightness for 20 seconds.
- ▶ The weather station can also set the backlight to automatically dim at night. Press and hold the “☀️ / ZZ” button for more than 3 seconds to enter the night mode setting.
- ▶ Press the “⚙️” button to confirm and move to the next item.
- ▶ Press the “▲MEM” or “▼WIFI” button to adjust the value. Press and hold the “▲MEM” or “▼WIFI” button to adjust quickly.

## Settings order:

1. Night mode on | off
2. Backlight brightness setting at night
3. Hour setting for night entry time
4. Minute setting for night entry time
5. Hour setting of night exit time
6. Minute setting of night exit time

**Note:** when the night function is set off, Press “⚙️” button to exit directly, omitting the settings of other items

**Note:** Wait for 20 seconds without pressing any buttons, or double-click on the “☀️ / ZZ” touch key to exit the settings modes.

▶ When the night mode is on, the icon “☀️” will be displayed. When the time reaches the designated night mode time, the backlight will automatically adjust to the set night mode brightness. When it reaches the designated time to exit night mode, the backlight will return to the original brightness

▶ In night mode, the backlight can be switched to the highest brightness for 15 seconds by press the “☀️ / ZZ” button.

## Low battery:

▶ If the “Indoor sensor” column is display the battery icon “🔋”, you need to replace the weather station’s battery as soon as possible,

## Mounting instructions (wireless sensor)

### Multi-combination wireless remote sensor

- ▶ Mount the sensor in an open area clear for 15 meters (50 feet) in all directions.
- ▶ The sensor should be mounted on a sturdy platform or bracket that is mounted 1.5 m (5 ft) above the ground.
- ▶ Secure the base of the sensor to the platform and support frame by tightening the large nut that secures the support rod to the base.
- ▶ During installation, ensure that the solar panel faces south to ensure correct wind direction readings. Note the 'N' North Embossed Mark on the top of the sensor. Use a compass to verify that the 'N' North Emboss mark

Installation method 1

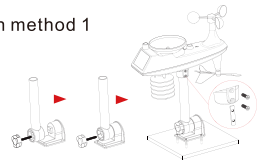

Installation method 2

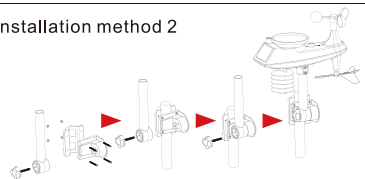

# VP7 WIFI Manual

aligns with the 'N' on the compass.

▶ When installing the sensor, use the top bubble level to ensure the sensor level, otherwise the accuracy of the rainfall reading will be affected.

▶ After completing the above two steps, tighten the two hexagon socket screws on the side of the sensor body.

▶ When installing, the fixing screws of the wind cup and the wind direction cursor should be tightened and tightened.

▶ The rainforest structure of the sensor needs to be cleaned regularly (recommended cycle 1-3 months, depending on the frequency of rain):

1. Remove the rainwater funnel (turn the rain sand funnel according to the direction of rotation shown).
2. Gently remove debris or insects from the rain sensor.
3. Remove debris from the rainwater funnel itself, especially debris from the funnel drain.
4. Remove the debris from the drain.
5. Reinstall the rainwater bucket.
6. Note: Do not apply oil to the rain sensor.

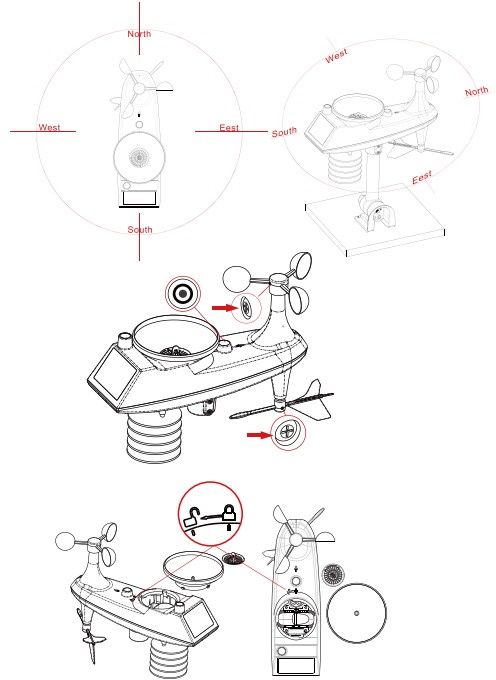

**Note:** Make sure the wireless sensor is installed within 100 meters of the weather station (empty, unobstructed). According to the thickness of the obstacle between the wireless sensor and the weather station, the distance should be shortened as much as possible (the distance after the wireless signal penetrates the obstacle will be shortened), otherwise the data transmission may be disturbed.

## Temperature | Humidity wireless remote sensor

(This sensor is not configured, please purchase separately if needed)

Option 1:

- ▶ Mount the mounting screws to the wall.
- ▶ Hang the wireless sensor on the screw.

Option 2:

- ▶ Insert the mounting screws through the front of the wireless sensor into the wall.
- ▶ Tighten the screws to fit snugly (do not overtighten).
- ▶ If placing the wireless sensor outdoors, install the temperature | humidity wireless sensor on a north-facing wall or in shade. The sun will make it even higher.
- ▶ Preferably, install the sensor under eaves or decks.
- ▶ Ensure the wireless sensor is mounted vertically to allow moisture to vent.

